



bryton®



Rider 15

User's Manual



Table of Contents

Getting Started	4	Bryton App Advanced Settings	18
Rider 15 Key Functions.....	4	Grid Setting.....	18
Reset Rider 15.....	4	Altitude Calibration	19
Accessories	5	Notification.....	20
Status Icons	5	Appendix	21
Step 1: Charge your Rider 15	6	Specifications	21
Step 2: Turn On Rider 15.....	6	Battery Information	22
Step 3: Initial Setup	6	Install Rider 15.....	24
Step 4: Acquire Satellite Signals.....	7	Install the Speed/Cadence/Dual Sensor (Optional)	25
Step 5: Ride Your Bike with Rider 15	7	Install Heart Rate Belt (Optional).....	26
Share Your Records	7	Wheel Size and Circumference ..	27
Sync to Bryton Mobile App.....	8	Basic Care For Your Rider 15	28
Download Bryton Update Tool ...	10	Data Fields	29
Settings	11		
Bike Profile.....	11		
Calibrate Altitude	12		
Sensor Pairing	12		
Delete Records	13		
GPS System	14		
Unit.....	15		
Hour	16		
Heading	17		
Adjust Odometer	17		

WARNING

Always consult your physician before you begin any training. Please read the details in Warranty and Safety information guide in the package.

Australian Consumer Law

Our goods come with guarantees that can not be excluded under the New Zealand and Australian Consumer Laws. You are entitled to a replacement or refund for a major failure and for compensation for any other reasonably foreseeable loss or damage. You are also entitled to have the goods repaired or replaced if the goods fail to be of acceptable quality and the failure does not amount to a major failure.

Video Tutorial

For a step-by-step demonstration of device and Bryton Mobile App, please scan below QR code to check Bryton Video Tutorials.



<https://www.youtube.com/c/DevelopmentBryton>

Getting Started

This section will guide you on the basic preparations before you start using your Rider 15.

Rider 15 Key Functions

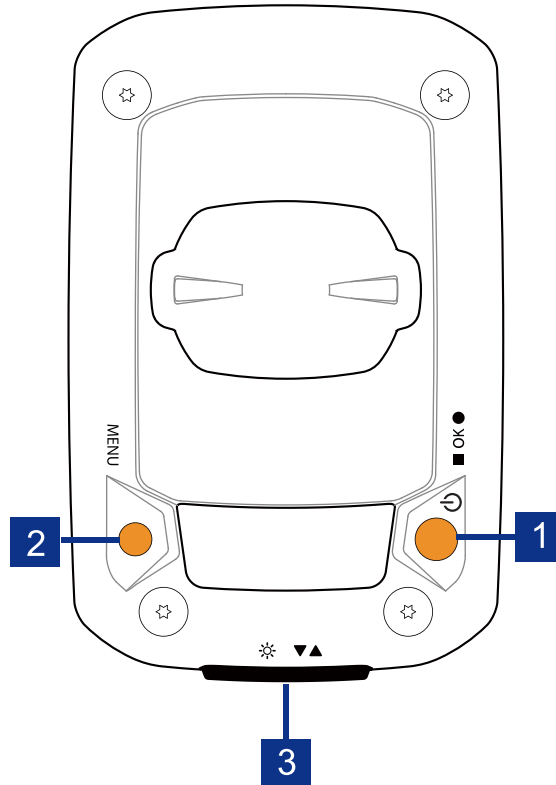

1 Power/OK (/)

- Press to turn the device on.
- Press and hold to turn the device off.
- In free cycling, press to start recording.
- When recording, press to stop recording.
- In Menu, press to confirm a selection.

2 MENU ()

- Press to enter/exit menu mode.
- Press to be back to main menu.
- Long press to clear notification icons.

3 Backlight/Page (/)

- Long press to turn on/off backlight.
- In Menu, press to move down to scroll through menu options.
- In Meter mode, press to switch meter screen page.

Reset Rider 15

To reboot the Rider 15, press two keys ( / ) at the same time.

Accessories





























The Rider 15 comes with the following accessories:

- USB Cable
- Bike Mount





Optional items:

- Smart Heart Rate Monitor
- Smart Speed Sensor
- Smart Cadence Sensor
- Sport Mount

Status Icons

Icon	Description	Icon	Description	Icon	Description
Bike Type		Settings		Data Field	
	Bike 1		Daylight Saving		Heart Rate Zone
	Bike 2		Backlight		Maximum Heart Rate
GPS Signal Status		AM	Morning	LT HR	Lactate Threshold Heart Rate
	No GPS Signal	PM	Afternoon	Sensor Pairing	
	Weak GPS signal	N	North		Heart Rate Sensor Paired
	Strong GPS signal		Heading		Speed Sensor Paired
	GPS+Galileo+QZSS+Glonass	Data Field			Cadence Sensor Paired
	GPS+Galileo+QZSS+Beidou		Gradient		Recording
Power Status		ALT▲	Altitude Gain		Auto Pause
	Full battery	ALT▼	Altitude Loss		Bluetooth Connected
	Half battery	R_{Time}	Ride Time		
	Low battery	T_{Time}	Trip Time		
Notification			Cadence Value		
	Incoming Call		Heart Rate Value		
	E-mail	ODO	Odometer		
	Message	D	Distance		
		D1	Distance 1		
		D2	Distance 2		
			Maximum		
			Average		

NOTE:

- Only the active icons are displayed on the screen.
- Device battery icon () starts blinking indicating that the battery is low.
- Sensor icons (, , ) start blinking indicating that paired sensors are not within connection range.

Step 1: Charge your Rider 15

Connect Rider 15 to a PC to charge the battery for at least 4 hours. Unplug the device when it is fully charged.

- You may see battery icon is blinking when the battery is really low. Keep the device plugged until it is properly charged.
- The temperature suitable for charging battery is 0°C ~ 40°C. Beyond this temperature range, charging will be terminated and the device will draw power from battery.

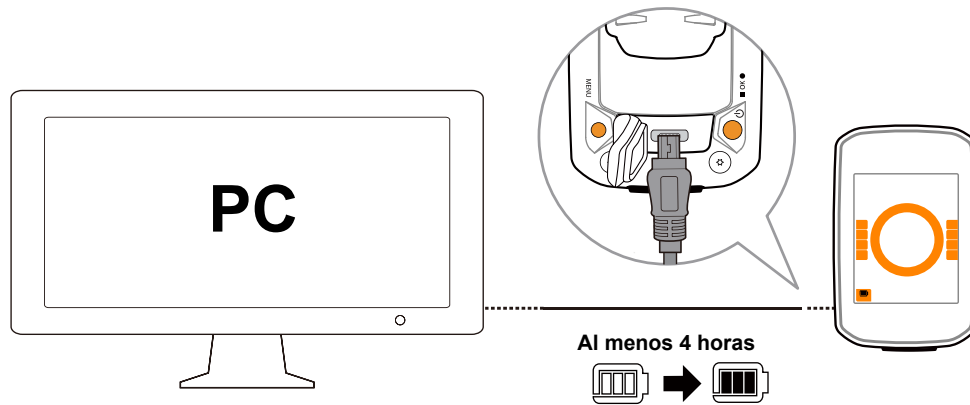



Step 2: Turn On Rider 15

Press  to turn on the device.

Step 3: Initial Setup



When turning Rider 15 on for the first time, the setup wizard appears on the screen. Follow the instruction to complete setup.

1. Press   to select the unit of measurement and temperature.





Step 4: Acquire Satellite Signals



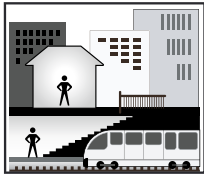
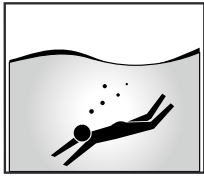
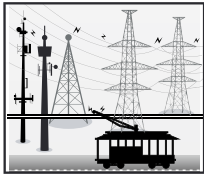

Once the Rider 15 is turned on, it will automatically search for satellite signals. It may take 30 to 60 seconds to acquire signals for the first time use.

The GPS signal Icon ( / ) appears when GPS is fixed .

- If GPS signal is not fixed, an  icon appears on the screen.
- Please avoid the obstructed environments since they might affect the GPS reception.

				
Tunnels	Inside rooms, building, or underground	Under water	High-voltage wires or television towers	Construction sites and heavy traffic

Step 5: Ride Your Bike with Rider 15

- **Free ride:**
In meter view, measurement starts and stops automatically in sync with the movement of the bicycle.
- **Start an exercise and record your data:**
In meter view, press  OK  to start recording, press  OK  again to stop.

Step 6: Share Your Records

Share Your Tracks to Brytonactive.com

1. Sign up Brytonactive.com

- a.Go to <https://active.brytonsport.com>.
- b.Register a new account.

2. Connect to PC

Turn on your Rider 15 and connect it to your computer by USB cable.

3. Share Your Records

- a.Click “+” on the right upper corner.
- b.Drop FIT, BDX, GPX file(s) here or Click “Select files” to upload tracks.
- c.Click “Activities” to check uploaded tracks.

Share Your Tracks to Strava.com

1. Sign up/log in on Strava.com

- a. Go to <https://www.strava.com>
- b. Register a new account or use your current Strava account to log in.

2. Connect to PC

Turn on your Rider 15 and connect it to your computer by USB cable.

3. Share Your Records

- a. Click “+” on the top right corner of Strava page and then click “File”.
- b. Click “Select Files” and select FIT files from Bryton device.
- c. Enter information about your activities and then click “Save & View”.

Sync Data to Bryton Mobile App

Launch Bryton Mobile App



1. Download Bryton Mobile App

Scan below QR Code to download Bryton App or you can go to Google Play for android/ App Store for iOS to search Bryton App and download it.



<http://download.brytonsport.com/inst.html>

2. Sign up Bryton Mobile App

- a. Launch Bryton Mobile App.
- b. Register a new account.

NOTE: Bryton Mobile App syncs with Brytonactive.com. If you already have brytonactive.com account, please use the same account to log in to Bryton Mobile App and vice versa.

Pair Your Device with Bryton Mobile App

With the connection to Bluetooth, your Rider computer easily uploads recorded tracks. To sync data correctly from your device, it is required to pair your device with Bryton mobile app before syncing data for the first time.

<p>a. Turn on “Bluetooth” on your mobile phone.</p> 	<p>b. Power on your Rider 15.</p> 	<p>c. Tap “ BT Sync”</p> 
<p>d. Select the device you would like to pair , and tap “+”.</p> 	<p>e. Tap “Yes” after checking if UUID shown on app is the same as your device’s.</p> <p>Note: UUID is the 16 digit number on the back of the device.</p> 	<p>f. Your device is successfully paired with Bryton app. Tap “Finish” .</p> <p>Note: Each device has its own unique UUID, and each UUID can only be added to one Bryton account.</p> 
<p>g. It would start uploading tracks from paired device. .</p> 	<p>h. All tracks are uploaded.</p> 	<p>i. Go to “Activities” and you can see tracks are uploaded successfully.</p> 

Upload Tracks with One Tap

After successfully pairing your device with Bryton Mobile App, when bluetooth is activated both on your phone and device, all of your activities will be uploaded automatically simply by tapping  icon in Bryton Mobile APP.

BT Sync

Download Bryton Update Tool

Bryton Update Tool is the tool for you to update GPS data, firmware, download Bryton Test and maps for multiple regions.

1. Go to <http://www.brytonsport.com/#/supportResult?tag=BrytonTool> and download Bryton Update Tool.
2. Follow the on-screen instructions to install Bryton Update Tool.

Update GPS Data

The newer GPS data can speed up the GPS acquisition. We highly recommend you to update GPS data for every 1-2 weeks.

Update Firmware

Bryton releases a new firmware version on irregular basis to add new functions or correct bugs for better and more stable performance. It is recommended that you update firmware once new firmware available. Firmware updates usually take longer to download and install. Do not remove USB cable during firmware updating.

NOTE: GPS data and new firmware version can also be updated via Data Sync function. Please refer to [page 9-11 : Sync Data to Bryton Mobile App](#)

Settings

Under Settings, you can customize Bike Profile, Tire Size, Altitude, Sync (Sensor Pairing), Device Storage, GPS, Unit of Measurement, Unit of Temperature, Hour, Daylight Saving, Heading and Odometer.

Bike Profile

You can select which bike profile you would like to activate and calibrate.

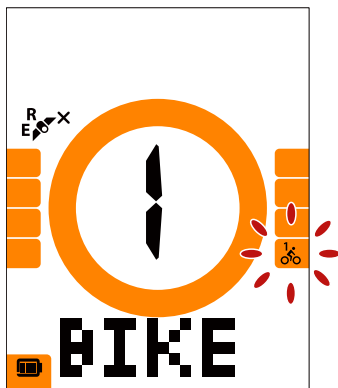

Bike 1 or Bike 2

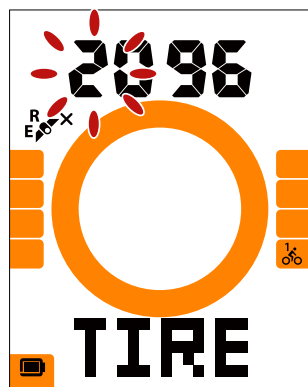

Tire Size

1. Press **MENU** to enter settings.
2. Press **OK** to enter Bike setting.
3. Press **▼▲** to select “Bike 1 or Bike 2” and press **OK** to confirm selection.
4. Rider continually leads you to adjust Tire Size. Press **▼▲** to select desired setting and press **OK** to confirm and move to next digit. Repeat above steps to complete setting. If there is no need to make change, press **MENU** to back to main menu, press again to exit menu.

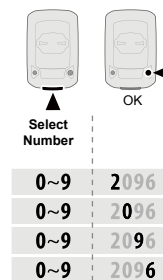

NOTE: Please refer to [page 27 Wheel Size and Circumference](#) for more detail.

5. After completing the setting, press **OK** to confirm and be back to main menu, then press **MENU** to exit menu.

Calibrate Altitude

You can set Altitude setting for current location.

NOTE: The value of altitude on the meter mode will be changed once current altitude is adjusted.

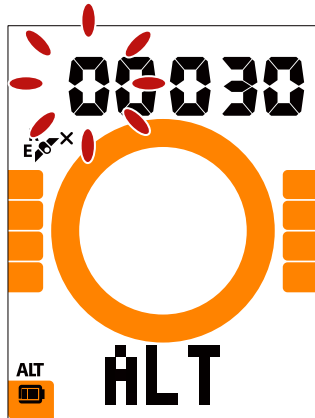

Altitude

1. Press MENU to enter settings.
2. Press ▼▲ to select “ALT” and press ■OK● to enter Altitude setting.
3. Press ▼▲ to select desired setting and press ■OK● to confirm and move to next digit. Repeat above steps to complete setting.

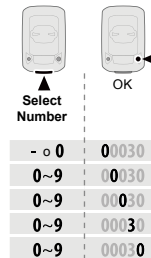

4. After completing the setting, press ■OK● to confirm and press MENU to exit menu.

Sensor Pairing

You can pair Heart Rate Sensor, Speed Sensor, Cadence Sensor and Dual Sensor with Rider 15.

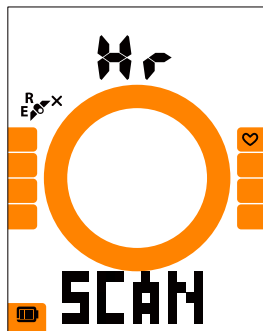

Heart Rate

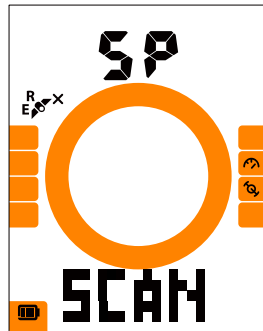

Speed Sensor

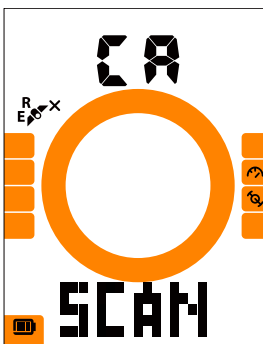

Cadence Sensor

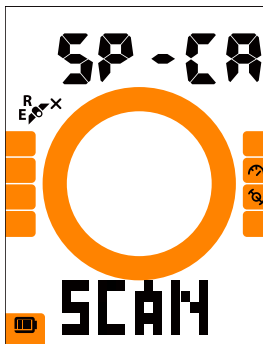

Dual Sensor

1. Press MENU to enter settings.
2. Press ▼▲ to select “SYNC” and press ■OK● to enter the setting.
3. Press ▼▲ to select “Hr, SP, CA or SP-CA” and press ■OK●.
4. Wear Heart Rate Sensor or rotate crank and wheel a few times to wake sensors up.

NOTE: The sensors can only be paired when they are awake, or they would go back to sleep to preserve power.

5. Wait for pairing. When Rider 10 shows “YES”, it means it successfully detects one sensor, press ■OK● to confirm pairing, press ▼▲ to select “NO” and press ■OK● to cancel and pair again.
6. After completing pairing, press MENU to exit menu.

NOTE:

- Please keep away from other BLE sensors during sensor pairing.
- After pairing, your Bryton devices automatically connect to Bryton Smart Sensors each time when sensors are awake.

Delete Records

You can delete all records or delete records to make space for 8h, 16h or 24h recording.

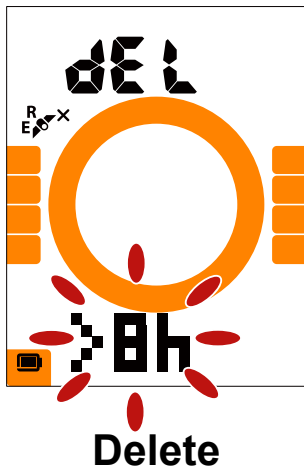

1. Press MENU to enter settings.
2. Press ▼▲ to select “DEL” and press ■OK● to enter.
3. Press ▼▲ to select “>8h,>16h, >24h or ALL” to delete records.
4. Press ■OK● to confirm selection.
5. Press MENU to exit menu.

NOTE:

- Rider 15 can record up to 120 hours in smart recording mode, and it can record up to 30 hours in 1 sec recording mode (It requires Bryton Mobile App to switch to 1 sec recording mode).
- You can view how many hours are left to record in Distance data field once you start riding or start recording.
- >8h,>16h or >24h only comes to use when Rider 15’s storage is less than 8h, 16h or 24h and it only makes enough space for 8h, 16h or 24h recording instead of adding up another 8h, 16h or 24h for you to record.

GPS System

Rider 15 has full GNSS (Global Navigation Satellite System) support including GPS , GLONASS (Russia), BDS (China), QZSS (Japan) and Galileo (EU). You can select the GPS+GLO mode or GPS+BDS mode according to your location to enhance accuracy or better suit your needs.

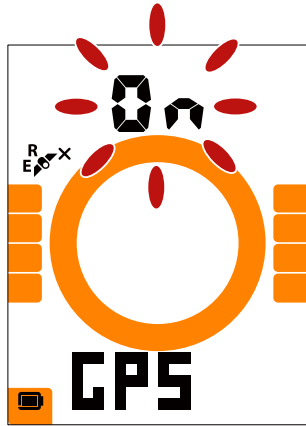

GPS

1. Press **MENU** to enter settings.
2. Press **▼▲** to select “GPS” and press **■OK●** to enter.
3. Press **▼▲** to select “On” to select different satellite system; select “OFF” to save power when GPS signal is not available, or when GPS information is not required (such as indoor use).
4. Press **▼▲** to select GPS+GLO or GPS+BDS and press **■OK●** to confirm.

- GPS+BDS : GPS+BeiDou Navigation Satellite System. By April 2018, BeiDou is offering service in the Asia-Pacific region. Choose this combination if you're in this region for best accuracy.

- GPS+GLO: GPS+GLONASS Navigation Satellite System. Glonass is the second navigational system working with global coverage and of comparable precision. Choose this combination if you're in NON Asia-Pacific region for best accuracy.

5. Press **MENU** to exit menu.

NOTE: Enabling either GPS+GLO or GPS+BDS also activates QZSS and Galileo satellites.

Unit

You can set km/h or mi/h as your unit of measurement, and set °C or °F as your unit of temperature.

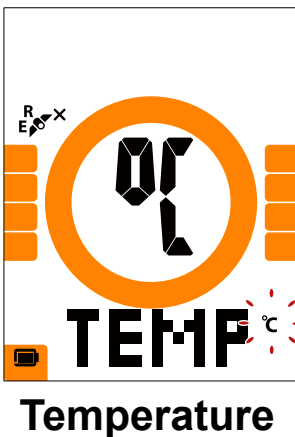
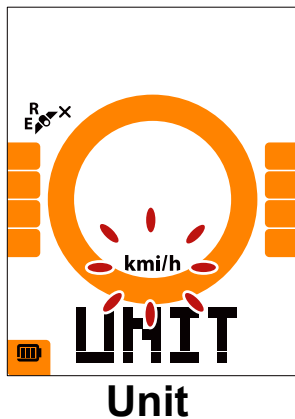

1. Press **MENU** to enter settings.
2. Press **■ OK ●** to enter “UNIT” setting.
3. Press **▼▲** to select “km/h or mi/h”.
4. Press **■ OK ●** to confirm selection.
5. Rider continually leads you to adjust unit of temperature.
6. Press **▼▲** to select “°C or °F”.
7. Press **■ OK ●** to confirm selection.
8. Press **MENU** to exit menu.

Hour

You can set time format as 12-hour clock or 24-hour clock and adjust daylight saving time.

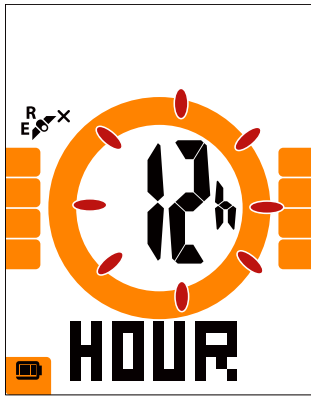

12h or 24h

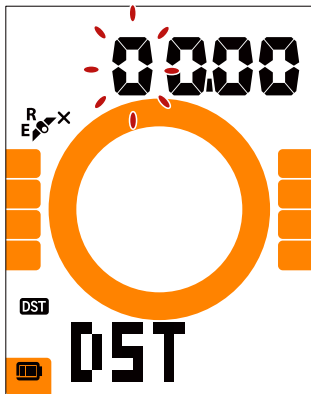

Daylight Saving Time

1. Press **MENU** to enter settings.
2. Press **▼▲** to select "HOUR" and press **■ OK ●** to enter HOUR setting.
3. Press **▼▲** to select "12h or 24h" and press **■ OK ●** to confirm selection.
4. Rider continually leads you to adjust Daylight Saving Time. Press **▼▲** to select desired setting and press **■ OK ●** to confirm and move to next digit. Repeat above steps to complete setting. If there is no need to make change, press **MENU** to be back to main menu, press again to exit menu.

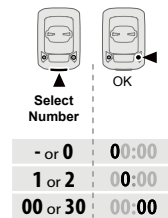

5. After completing the setting, press **■ OK ●** to confirm and be back to main menu, then press **MENU** to exit menu.

Heading

Heading function informs you which direction you are currently heading. Rider 15 has 2 display modes, the Compass Mode for pointing to the North and the Map Mode for pointing to current direction.

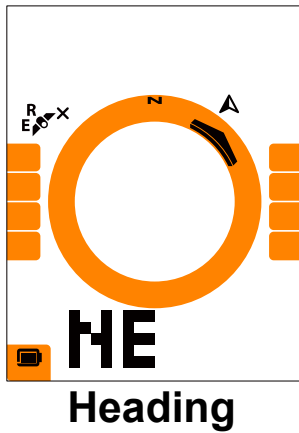

Heading

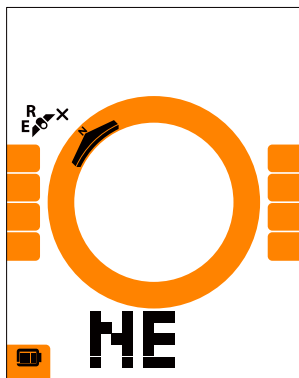

Compass

1. Press **MENU** to enter settings.
2. Press **▼▲** to select “NE”.
3. Press **■OK●** to enter “NE” setting.
4. Press **▼▲** to select “Heading or Compass”.
5. Press **■OK●** to confirm selection.
6. Press **MENU** to exit menu.

Adjust Odometer

You can adjust total mileage on the odometer setting.

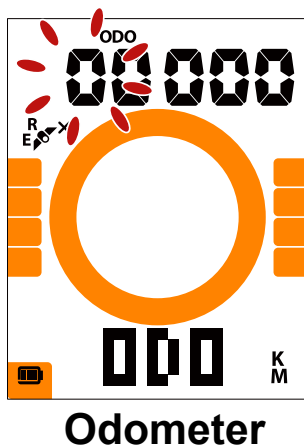

Odometer

1. Press **MENU** to enter settings.
2. Press **▼▲** to select “ODO” and press **■OK●** to enter odometer setting.
3. Press **▼▲** to select desired setting and press **■OK●** to confirm and move to next digit. Repeat above steps to complete setting.

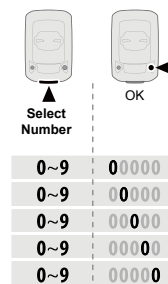

4. After completing the setting, press **■OK●** to confirm and press **MENU** to exit menu.

Bryton App Advanced Settings

After pairing your Rider 15 with Bryton Mobile App, you will have access to Grid Setting and Altitude Calibration.

Grid Setting

You can customize your data page manually, set your MHR, LTHR, turn on/off Smart Pause and set Data Recording.

1. Pair Rider 15 with Bryton Mobile App

- a. Turn on Rider 15.
- b. Go to your phone "Settings>Bluetooth" and enable Bluetooth.
- c. Go to Bryton Mobile App and tap "Settings>User Settings>Device Manager".
- d. Tap "+" and choose "Bluetooth 4.0".
- e. Select and add your device by pressing "+".
- f. Tap "Pair" to pair your device with your phone. (For iOS phone only)
- g. Tap "Finish" to complete pairing.

2. Customize Your Data Page

- a. Tap "Settings > Grid Setting" in Bryton Mobile App
- b. Tap "OK" to confirm connection to Rider 15.
- c. Choose "Manual" for personal customization.
Choose "Auto" if you want to keep it at Default.
- d. Tap left or right to change the number of grids.
- e. Tap 1, 2, 3, 4, 5 to switch to different data page.
- f. Tap data grid to change ride data.

3. Enter Your MHR and LTHR

- a. Tap "  " to enter settings.
- b. Tap number next to MHR and LTHR to enter your MHR and LTHR value.

4. Turn On/Off Smart Pause

Tap Smart Pause column to turn on/off smart pause.

5. Set Data Recording

Tap Data Recording column to set your desired settings.

6. Sync New Settings to Rider 15

Tap left upper corner "<" and select "Sync" to sync your new settings.

NOTE:

- To change data grid back to default, go to  and tap Data Page. "Back to default settings?" message pops up, tap "Yes" to confirm.
- To view step by step tutorial, please click below link. [Bryton Rider 15/10/one | Grid Setting with Bryton app](#)

Altitude Calibration

With connection to Internet, Bryton Mobile App provides altitude information for you to calibrate directly. You can also change altitude manually.

1. Pair Rider 15 with Bryton Mobile App

- a. Turn on Rider 15.
- b. Go to your phone “Settings>Bluetooth” and enable Bluetooth.
- c. Go to Bryton Mobile App and tap “Settings>User Settings>Device Manager”.
- d. Tap “+” and choose “Bluetooth 4.0”.
- e. Select and add your device by pressing “+”.
- f. Tap “Pair” to pair your device with your phone. (For iOS phone only)
- g. Tap “Finish” to complete pairing.

2. Calibrate Your Altitude

- a. Tap “Alt. Cal” in Bryton Mobile App.
- b. Tap “Allow” to enable Bryton Mobile App to use current location for altitude information. (For iOS phone only)
- c. Bryton Mobile App shows altitude of your current location. You can also make manual changes by pressing ▲ ▼ or tap on the number to input manually.
- d. Tap “Calibrate” to make change as suggested.
- e. Bryton Mobile App scans for available devices. Tap “OK” to connect to Rider 15.
- f. Tap “OK” to calibrate altitude data for your device.
- g. “Calibration Successful” shows up. Tap “OK” to confirm.

Note: To view step by step tutorial, please click below link.
[Bryton Rider 15/10 | Altitude Calibration with Bryton app](#)

Notification

After pairing your compatible smartphone using Bluetooth Smart wirelessly technology with Rider 15, you can receive phone call, text and email notifications on your Rider 15.

1. IOS Phone Pairing

- a. Turn on Rider 15.
- b. Go to your phone “Settings>Bluetooth” and enable Bluetooth.
- c. Go to Bryton Mobile App and tap “Settings>User Settings>Device Manager”.
- d. Tap “+” and choose “Bluetooth 4.0”.
- e. Select and add your device by pressing “+”.
- f. Tap “Pair” to pair your device with your phone.
- g. Tap “Finish” to complete pairing.

NOTE:

- If notifications don't work, please go to your phone “Settings>Notifications” and check if you have allowed notifications in compatible messages and email apps or go to social applications and check if you have turned on notifications in your application settings.
- To clear notification icons, please long press MENU.
- To view step by step tutorial, please click [Bryton Rider15/10/one | Notifications setup \(iOS\)](#).

1 Android Phone Pairing

- a. Turn on Rider 15.
- b. Go to your phone “Settings>Bluetooth” and enable Bluetooth.
- c. Go to Bryton Mobile App and tap “Settings>User Settings>Device Manager”.
- d. Tap “+” and choose “Bluetooth 4.0”.
- e. Select and add your device by pressing “+”.
- f. Tap “Finish” to complete pairing.

2. Allow Notification Access

- a. Tap “Settings>User Settings>Notification”.
- b. Tap “OK” to enter setting to allow Notification Access for Bryton app.
- c. Tap “Bryton” and select “OK” to allow notification access for Bryton.
- d. Go back to Notification settings.
- e. Select and enable In-coming Calls, Text Messages and Emails by tapping each item.

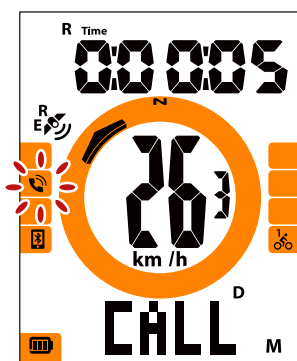

In-coming Calls

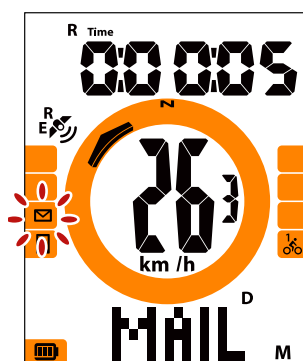

Emails

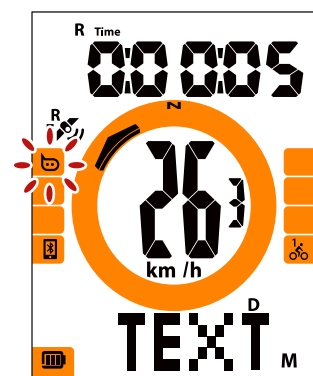

Text Message

NOTE:

- To view step by step tutorial, please click [Bryton Rider15/10/one | Notifications setup \(Android\)](#).
- To clear notification icons, please long press MENU.

Appendix

Specification

Rider 15

Item	Description
Display	2" Segment Type HTN LCD
Physical Size	71 x 46,2 x 16,5 mm.
Weight	52 g
Operating Temperature	-10°C ~ 50°C
Battery Charging Temperature	0°C ~ 40°C
Battery	Li-polymer rechargeable battery
Battery Life	16 hours with open sky
GPS	Integrated high-sensitivity GPS receiver with embedded antenna
BLE Smart	Bluetooth smart wireless technology with embedded antenna
Water Resistant	Water resistant to a depth of 1 meter for up to 30 minutes
Barometer	Equipped with barometer

Smart Speed Sensors

Item	Description
Physical Size	36.9 x 34.8 x 8.1 mm
Weight	6 g
Water Resistance	Incidental exposure to water of up to 1 meter for up to 30 minutes
Transmission Range	3 m
Battery Life	Up to 1 year
Operating Temperature	-10°C ~ 60°C
Radio Frequency/ protocol	2.4GHz / Bluetooth 4.0 and Dynastream ANT+ Sport wireless communications protocol

NOTE:

Accuracy may be degraded by poor sensor contact, electrical, magnetic interference and distance from the transmitter.

To avoid magnetic interference, it is recommended that you change location, clean or replace chain.

Smart Cadence Sensor

Item	Description
Physical Size	36.9 x 31.6 x 8.1 mm
Weight	6 g
Water Resistance	Incidental exposure to water of up to 1 meter for up to 30 minutes
Transmission Range	3 m
Battery Life	Up to 1 year
Operating Temperature	-10°C ~ 60°C
Radio Frequency/ protocol	2.4GHz / Bluetooth 4.0 and Dynastream ANT+ Sport wireless communications protocol

NOTE:

Accuracy may be degraded by poor sensor contact, electrical, magnetic interference and distance from the transmitter.

Smart Heart Rate Monitor

Item	Description
Physical Size	63 x 34,3 x 15 mm.
Weight	14,5 g (sensor) / 31,5 g (correa)
Water Resistance	Incidental exposure to water of up to 1 meter for up to 30 minutes
Transmission Range	3 m
Battery Life	Up to 2 years
Operating Temperature	0°C ~ 50°C
Radio Frequency/ protocol	2.4GHz / Bluetooth 4.0 and Dynastream ANT+ Sport wireless communications protocol

Battery Information

Smart Speed Sensor and Smart Cadence Sensor

Both sensors contain a user-replaceable CR2032 battery.

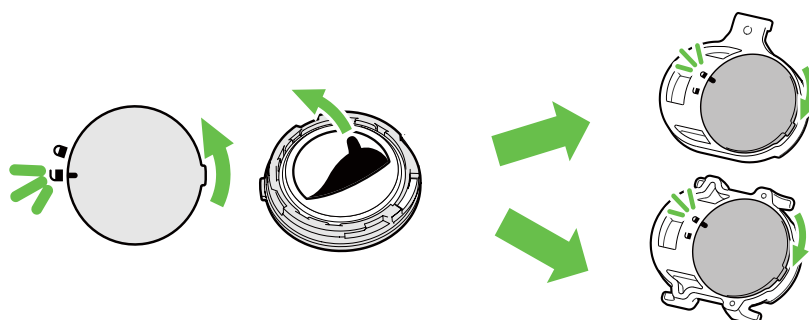

Before using sensors:

1. Locate the circular battery cover on the back of sensors.
2. Use your finger to press and twist cover counter-clockwise so the indicator on the cover points to unlock icon (🔓).
3. Remove the cover and battery tab.
4. Use your finger to press and twist cover clockwise so the indicator on the cover points to locked icon (🔒).

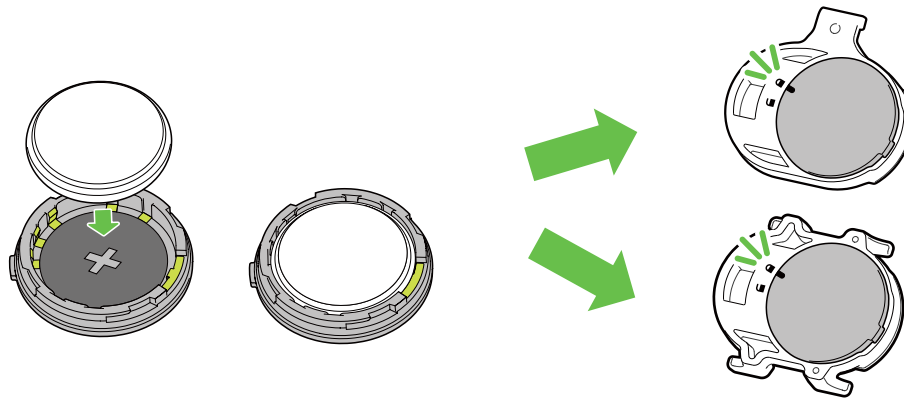



To replace the battery:

1. Locate the circular battery cover on the back of sensors.
2. Use your finger to press and twist cover counter-clockwise so the indicator on the cover points to unlock icon ().
3. Remove the battery and insert new battery with positive connector first into the battery chamber.
4. Use your finger to press and twist cover clockwise so the indicator on the cover points to locked icon ().

NOTE:

- Value of cadence or speed blinks in data page when sensors having low power.
- When installing a new battery, if the battery is not placed with the positive connector first, the positive connector will easily deform and malfunction.
- Be careful not to damage or lose O-ring gasket on the cover.
- Contact your local waste disposal department to properly dispose of used batteries.

Smart Heart Rate Monitor

The heart rate monitor contains a user-replaceable CR2032 battery.

To replace the battery:

1. Locate the circular battery cover on the back of the heart rate monitor.
2. Use a coin to twist the cover counter-clockwise.
3. Remove the cover and battery.
4. Insert the new battery, with the positive connector facing upward and lightly press it.
5. Use a coin to twist the cover clockwise.

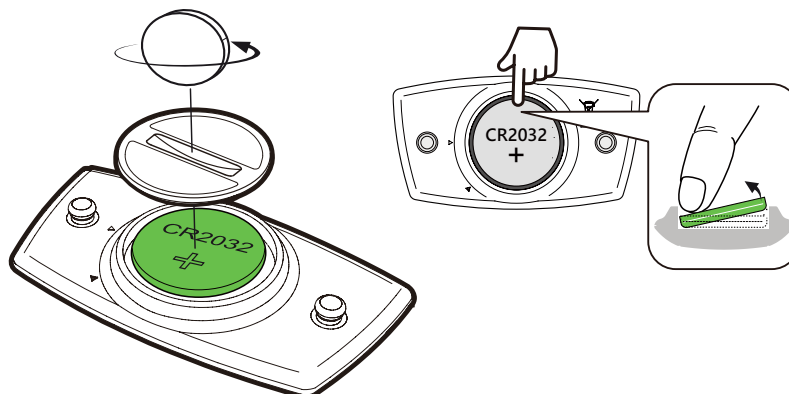

NOTE:

- Value of heart rate blinks in data page when heart rate sensor is having low power.
- Be careful not to damage or lose the O-ring gasket.
- Contact your local waste disposal department to properly dispose of of used batteries.

Install Rider 15

Use Bike Mount to Mount Rider

1

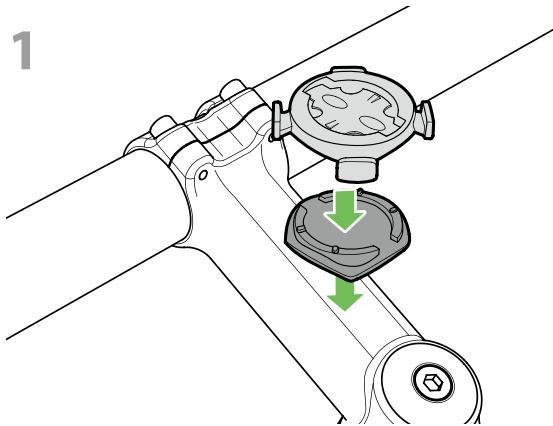

2

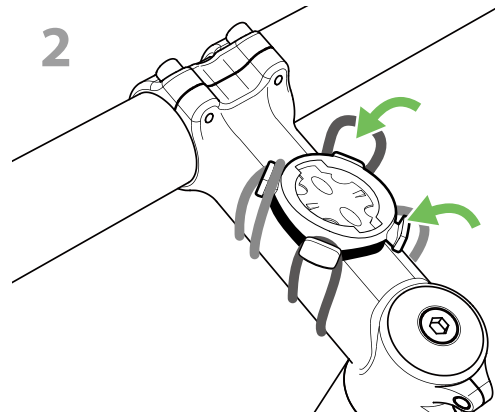

3

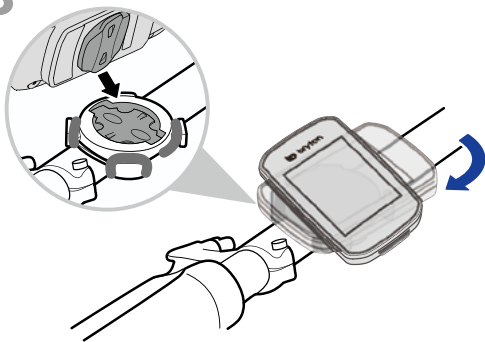

4

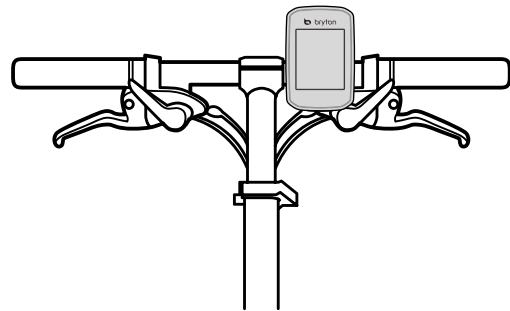

Use F-Mount to Mount Rider (Optional)

1

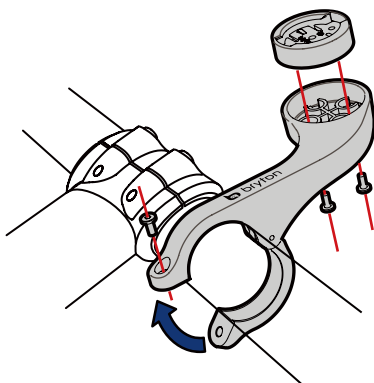

2

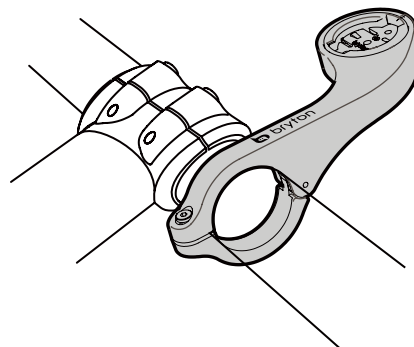

Install the Speed/Cadence Sensor (Optional)

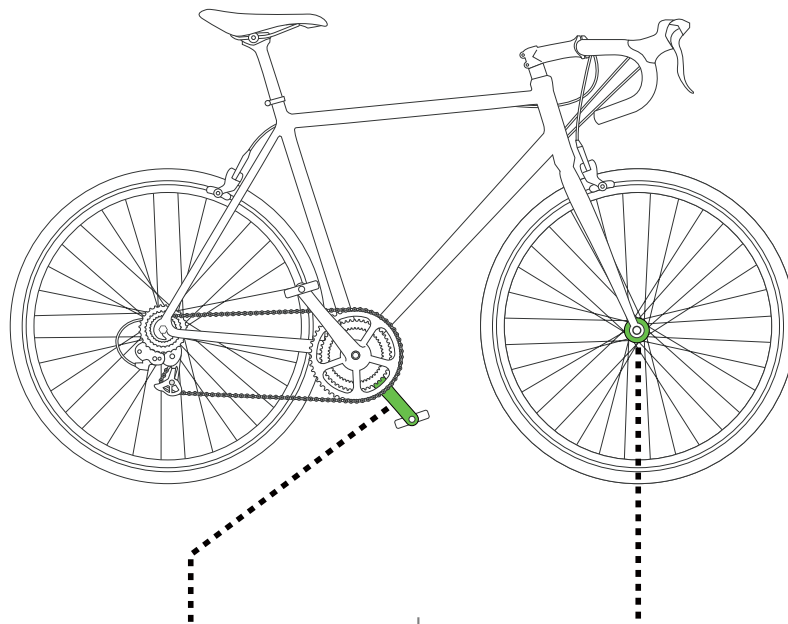

Smart Cadence Sensor

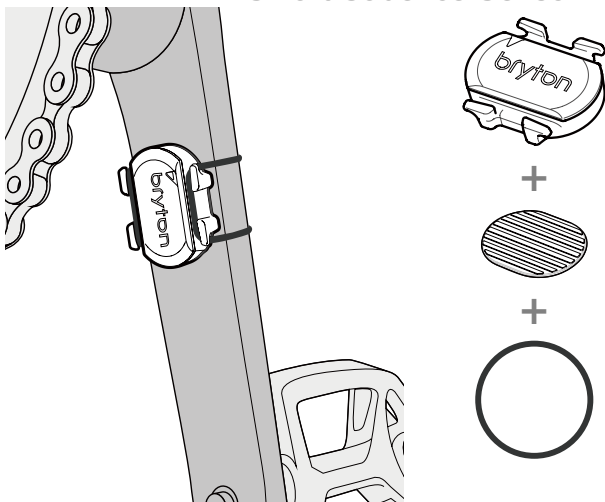

Smart Speed Sensor

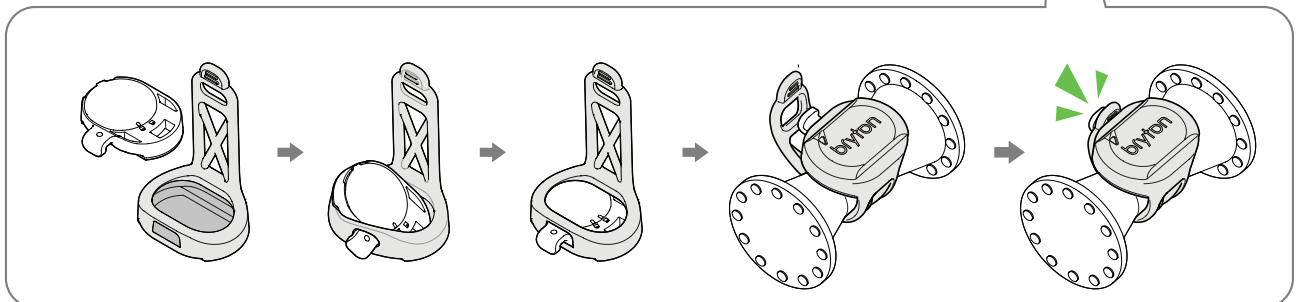
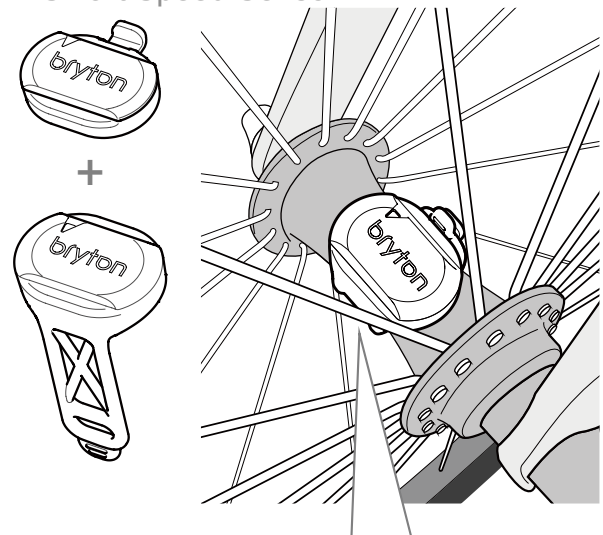

NOTE:

- Once sensors are waken, the LED blinks twice. The LED continues to blink when you continue to pedal for pairing. After around 15 times blink, it stops blinking. If not used for 10 minutes, sensor would go into sleep mode to preserve power. Please complete the pairing during the time the sensor is awake.

Install Heart Rate Belt (Optional)

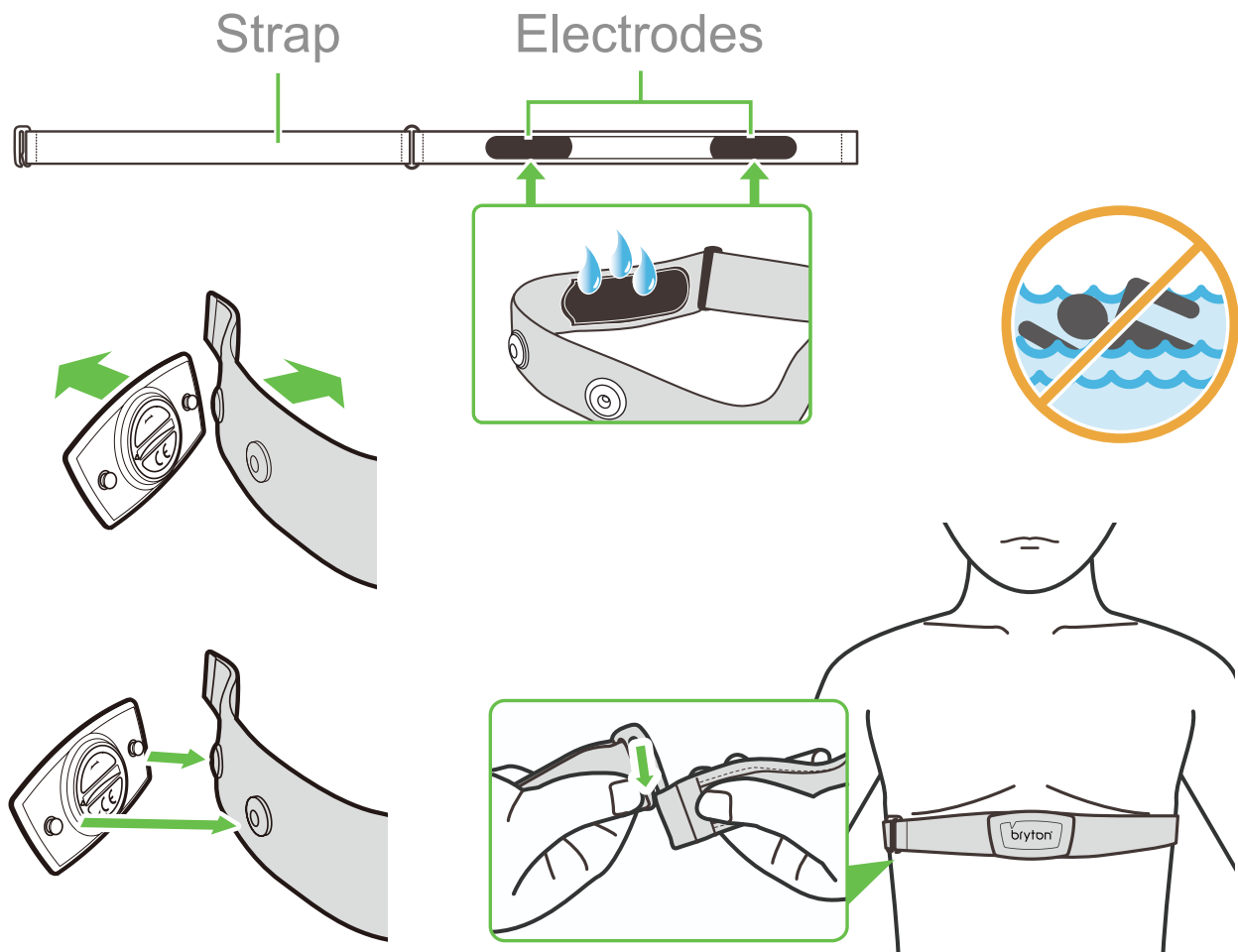

NOTE:

- In cold weather, wear appropriate clothing to keep the heart rate belt warm.
- The belt should be worn directly on your body.
- Adjust the sensor position to the middle part of the body (wear it slightly below the chest). The Bryton logo shown on the sensor should be facing upward. Tighten the elastic belt firmly so that it will turn loose during the exercise.
- If the sensor cannot be detected or the reading is abnormal, please warm up for about 5 minutes.
- If the heart rate belt is not used for a period of time, remove the sensor from the heart rate belt.

NOTE: Improper battery replacement may cause an explosion. When replacing a new battery, use only the original battery or a similar type of battery specified by the manufacturer. Disposal of the used batteries must be carried out in accordance to the regulations of your local authority.



For better environmental protection, waste batteries should be collected separately for recycling or special disposal.

Wheel Size and Circumference

The wheel size is marked on both sides of the tires.

Wheel Size	L (mm)
12x1,75	935
12x1,95	940
14x1,50	1020
14x1,75	1055
16x1,50	1185
16x1,75	1195
16x2,00	1245
16 x 1-1/8	1290
16 x 1-3/8	1300
17x1-1/4	1340
18x1,50	1340
18x1,75	1350
20x1,25	1450
20x1,35	1460
20x1,50	1490
20x1,75	1515
20x1,95	1565
20x1-1/8	1545
20x1-3/8	1615
22x1-3/8	1770
22x1-1/2	1785
24x1,75	1890
24x2,00	1925
24x2,125	1965
24 x 1 (520)	1753
Tubular 24 x 3/4	1785
24x1-1/8	1795
24x1-1/4	1905
26 x 1 (559)	1913
26x1,25	1950
26x1,40	2005
26x1,50	2010
26x1,75	2023
26x1,95	2050
26x2,10	2068
26x2,125	2070
26x2,35	2083

Wheel Size	L (mm)
26x3,00	2170
26x1-1/8	1970
26x1-3/8	2068
26x1-1/2	2100
650C Tubular 26 x7/8	1920
650x20C	1938
650x23C	1944
650 x 25C 26 x1 (571)	1952
650x38A	2125
650x38B	2105
27 x 1 (630)	2145
27x1-1/8	2155
27x1-1/4	2161
27x1-3/8	2169
27,5x1,50	2079
27,5x2,1	2148
27,5x2,25	2182
700x18C	2070
700x19C	2080
700x20C	2086
700x23C	2096
700x25C	2105
700x28C	2136
700x30C	2146
700x32C	2155
700C Tubular	2130
700x35C	2168
700x38C	2180
700x40C	2200
700x42C	2224
700x44C	2235
700x45C	2242
700x47C	2268
29x2,1	2288
29x2,2	2298
29x2,3	2326

Basic Care For Your Rider 15

Taking good care of your device will reduce the risk of damage to your device.

- Do not drop your device or subject it to severe shock.
- Do not expose your device to extreme temperatures and excessive moisture.
- The screen surface can easily be scratched. Use the non-adhesive generic screen protectors to help protect the screen from minor scratches.
- Use diluted neutral detergent on a soft cloth to clean your device.
- Do not attempt to disassemble, repair, or make any modification to your device. Any attempt to do so will make the warranty invalid.

Data Fields

BLE sensors' connection to your device or Bryton Mobile App is required to display some data field.

Time : Current GPS Time

Ride Time : The time spent on riding for current activity.

Trip Time : Total time recorded including pauses.

Distance : The distance traveled for current activity.

Odometer : The accumulated total distance until you reset it.

Distance 1, Distance 2: Cumulative mileage recorded before you reset it. They are 2 separate distance measurements. You are free to use Distance 1 or Distance 2 to record, for example, weekly total distance and use another to record, for example, monthly total distance. It requires Bryton Mobile App to enable this function.

Speed : The current rate of change in distance.

Average Speed : The average speed for current activity.

Maximum Speed : The maximum speed for current activity.

Cadence : The current rate at which rider is pedaling the pedals. It requires compatible BLE cadence sensor connection to your device .

Average Cadence : The average cadence for current activity.

Maximum Cadence : The maximum cadence for current activity.

Heart Rate : The number of times your heart beats per minute. It requires compatible HR cadence sensor connection to your device .

Heart Rate Zone : The current range of your heart rate.

Average Heart Rate : The average heart rate for current activity.

Maximum Heart Rate : The maximum heart rate for current activity.

LTHR : The average heart rate while in the intense exercise at which the blood concentration of lactate begins to exponentially increase.

LTHR% : Your current heart rate divided by Lactate Theshold Heart Rate.

LTHR Zone : The current range of your LTHR.

The content of this manual is subject to change without prior notice



RF Exposure Information (MPE)

This device meets the EU requirements and the International Commission on Non-Ionizing Radiation Protection (ICNIRP) on the limitation of exposure of the general public to electromagnetic fields by way of health protection. To comply with the RF exposure requirements, this equipment must be operated in a minimum of 20 cm separation distance to the user.

Hereby, Bryton Inc. declares that the radio equipment type Bryton product is in compliance with Directive 2014/53/EU. The full text of the EU declaration of conformity is available at the following internet address:

http://www.brytonsport.com/download/Docs/CeDocs_Rider15.pdf



Designed by Bryton Inc.

Copyright © 2018 Bryton Inc. All rights reserved.

7F, No.75, Zhouzi St., Neihu Dist., Taipei City 114, Taiwan (R.O.C.)